

# THE ANIMATED HERO CLASSICS®

Resource & Activity Book

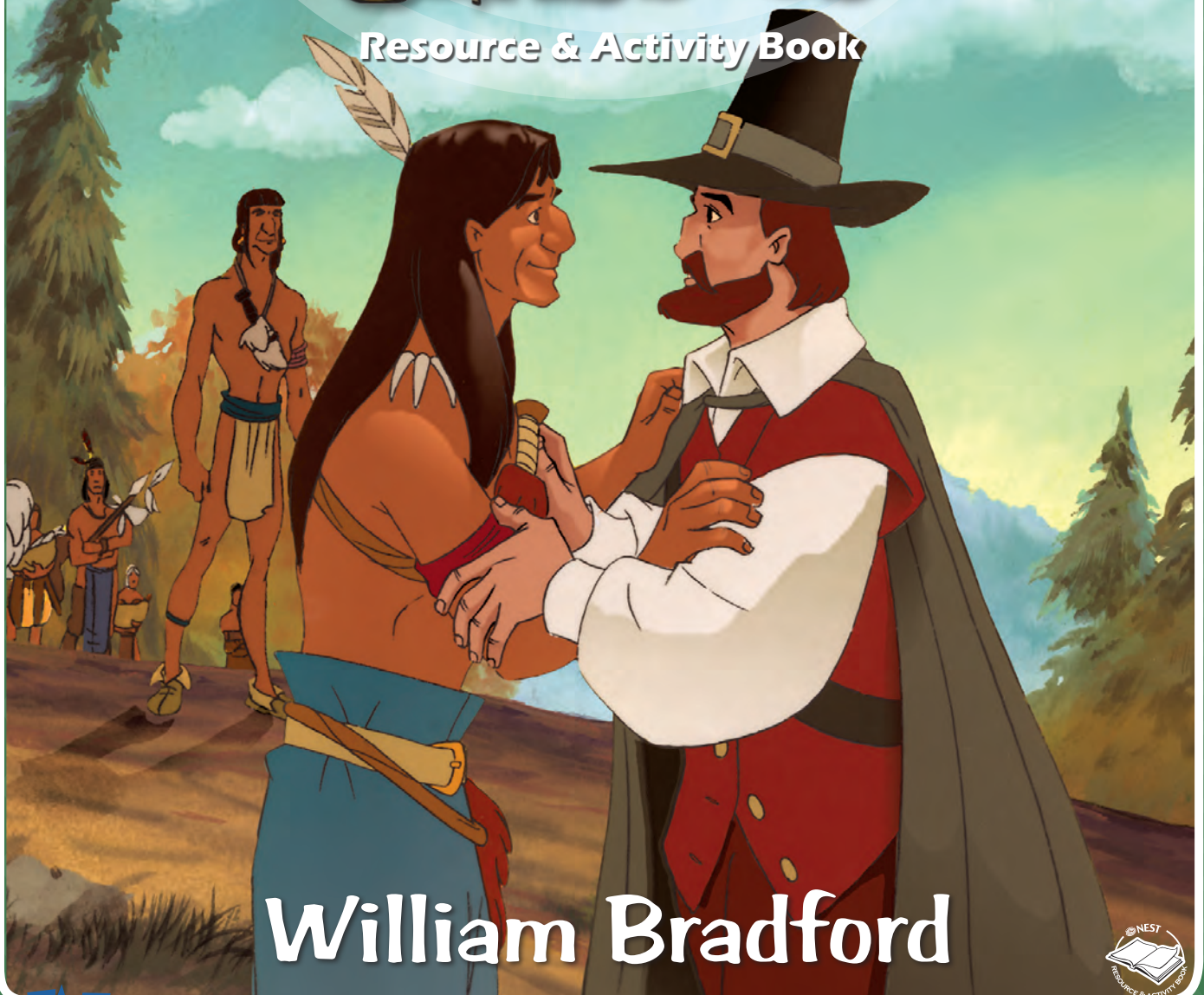

William Bradford



What's  
Inside?

Fun and Engaging • Curriculum Extension  
Reinforces Learning • Skill Level Activities

*"May not and ought not our children rightly say,  
Our fathers were Englishmen which came over this great ocean,  
ready to perish in this wilderness for freedom.  
But by the grace of God, they were saved."*

*-William Bradford*

#### PERMISSION TO REPRODUCE

This Resource & Activity Book contains proprietary information, which is protected by copyright. All rights are reserved. However, any part of this book may be reproduced for personal or classroom use as long as it is not sold. Such permission does not include the storage of any part of this publication in a retrieval system or the transmission of such, in any form, or by any means, electronic, mechanical, recording, etc., without prior written permission of the publisher. This permission applies only to the printed material in this Resource & Activity Book and does not extend to any audio or video production released or distributed by NEST Family Entertainment™. For additional certificates or Resource & Activity Books, contact: NEST Family Entertainment™, LLC. 1461 S. Beltline Rd., Suite 500, Coppell, TX 75019.

# TABLE of CONTENTS

Using Your <b>William Bradford</b> Resource & Activity Book .....	4
<b>Pictures To Color Section</b> .....	5
<b>Questions, Games &amp; Activities Sections</b> .....	
Questions .....	
Dot-To-Dots .....	
Which Picture Does Not Belong? .....	
What's Wrong With This Picture? .....	
Word Search.....	
Which Word Does Not Belong? .....	
Which Happened First?.....	
Mazes .....	
Which Picture Is Not Like The Others? .....	
Count The Diamonds.....	
Crossword Puzzle .....	
Word Search.....	
Matching Game .....	
Hidden Objects .....	
What's Different? .....	
Things For Groups To Discuss And Do .....	
Facts Not Fiction .....	
Game Cards .....	
<b>Ideas For Group Activities</b> .....	42
<b>Answer Key For Questions, Games &amp; Activities</b> .....	
<b>Certificate Of Achievement</b> .....	

# REFERENCES

## USING YOUR “WILLIAM BRADFORD - THE FIRST THANKSGIVING” RESOURCE & ACTIVITY BOOK

The purpose of this Resource & Activity Book is to provide individuals, families, and groups alike with fun and entertaining ways to learn more about William Bradford and the first Thanksgiving.

The book is divided into two main sections; the **“Pictures to Color Section”** and the **“Questions, Games, & Activities Section.”** Although most of the answers to each activity can be found by watching the **“William Bradford – The First Thanksgiving”** video there are a few which cannot. Therefore, an answer key is located in the back of the book for your convenience.

**REFERENCES:** For those wishing to further study the life of William Bradford or the history of Plymouth Plantation, we have listed the references used in researching the “William Bradford – The First Thanksgiving” video and Resource & Activity Book below. We highly recommend using these books in beginning your studies.

### REFERENCES

Bradford, William. “Of Plymouth Plantation, 1620-1647.” New York, New York.

Graves, Charles, P. “Colony Leader; William Bradford.” Illinois.

Smith, Bradford. “William Bradford: Pilgrim Boy.” Bobbs-Merrill, Indianapolis, Indiana, 1963.

“The World Book Encyclopedia.” Field Enterprises, Inc., 1959.

Westbrook, Perry, D. “William Bradford.” Boston, Massachusetts.

# REFERENCES

## WILLIAM BRADFORD The First Thanksgiving

### Pictures to Color



**“On to Holland!”**



**An English Magistrate arrests the Pilgrims.**

May be reproduced for non-commercial, personal or classroom use per Permission to Reproduce guidelines.  
All other rights reserved. ©2008 NEST Family Learning



**The Pilgrims sail toward America.**





**“The main mast is unstable! We’ll have to turn back!”**

May be reproduced for non-commercial, personal or classroom use per Permission to Reproduce guidelines.  
All other rights reserved. ©2008 NEST Family Learning

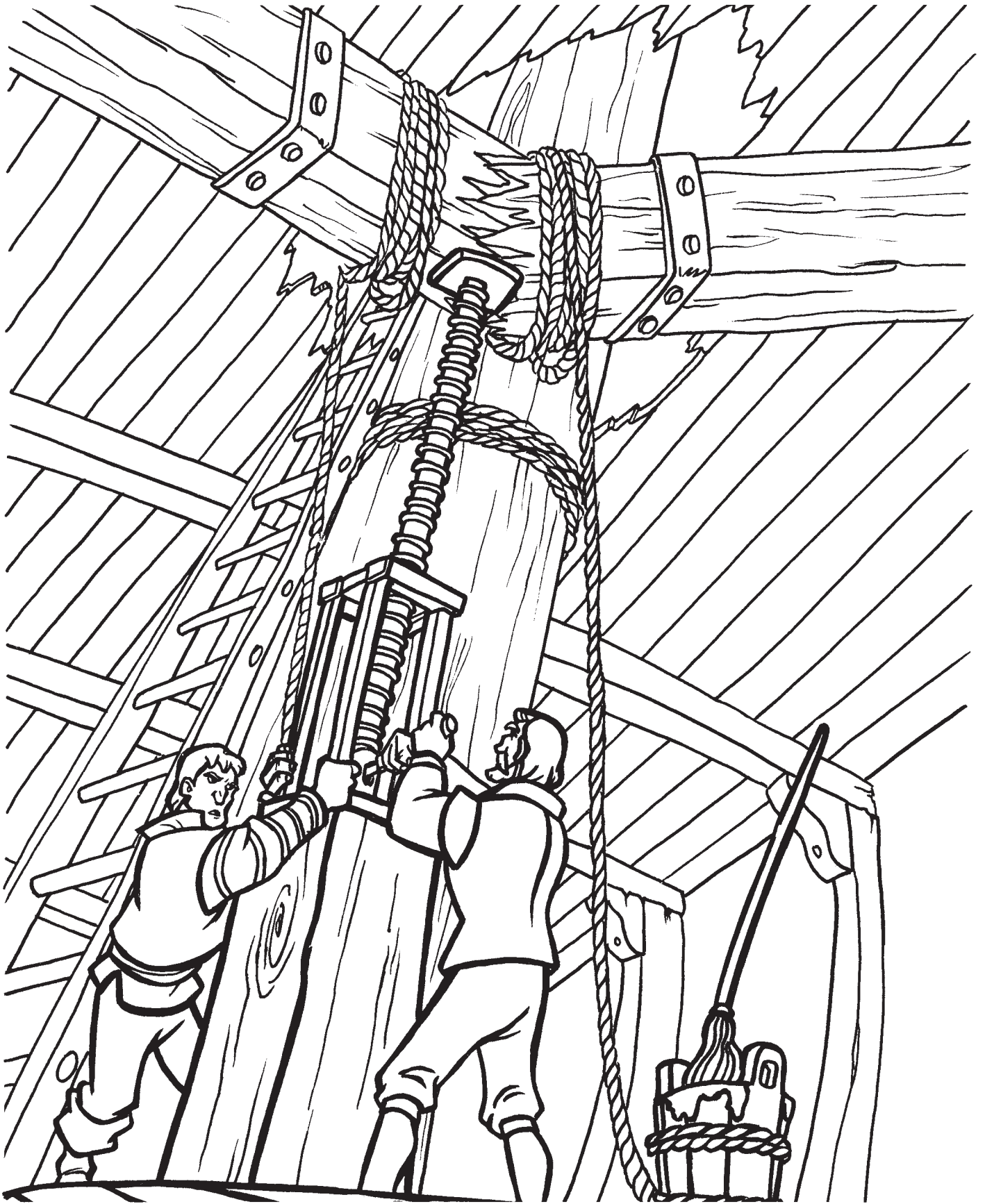

**The Pilgrims' jack is used to repair the main beam.**



**The Pilgrims rejoice when land is finally sighted.**

May be reproduced for non-commercial, personal or classroom use per Permission to Reproduce guidelines.  
All other rights reserved. ©2008 NEST Family Learning



**John Carver is elected as the first Governor in America.**



**William Bradford plans to make friends with the Indians.**

May be reproduced for non-commercial, personal or classroom use per Permission to Reproduce guidelines.  
All other rights reserved. ©2008 NEST Family Learning



**Samoset is friendly to the Pilgrims.**



**Massasoit and Squanto come to meet the Pilgrims.**

May be reproduced for non-commercial, personal or classroom use per Permission to Reproduce guidelines.  
All other rights reserved. ©2008 NEST Family Learning



The Pilgrims and Indians agree to live peacefully in the new world.





**Squanto teaches the Pilgrims how to survive in their new home.**

May be reproduced for non-commercial, personal or classroom use per Permission to Reproduce guidelines.  
All other rights reserved. ©2008 NEST Family Learning



Governor Carver is very sick.



**William Bradford is elected to be the next Governor.**

May be reproduced for non-commercial, personal or classroom use per Permission to Reproduce guidelines.  
All other rights reserved. ©2008 NEST Family Learning



**The Pilgrims and Indians celebrate the first Thanksgiving together.**

# REFERENCES

## WILLIAM BRADFORD The First Thanksgiving

Questions,  
Puzzles,  
Games &  
Activities

## ??? QUESTIONS ???

1. What happened when the Pilgrims were trying to go to Holland from England?
2. Why did the Pilgrims want to leave England?
3. What year did the Pilgrims sail to America?
4. What ship did the Pilgrims sail to America on?
5. Why did the Mayflower nearly have to sail back to England?
6. Why did the Pilgrims bring a jack with them to America?
7. What purpose did the jack serve on board the Mayflower?
8. Who was elected to be the first Governor over the colony?
9. What did the Pilgrims name their colony in America?
10. Who was the first Indian to visit the Pilgrims?
11. Name two Indians that spoke English.
12. Who made it possible for the Colonists to survive in America the first year?
13. How many Pilgrims died during the first year in America?
14. Why did Squanto want to live with the Pilgrims?
15. What happened to Squanto's tribe?
16. How did Squanto learn to speak English?
17. Name something that Squanto taught the Pilgrims.
18. Who became the second Governor of the colony?
19. What celebration did the Pilgrims start that we still celebrate today?
20. Why did the Pilgrims have a celebration?

6 • 7 • 8

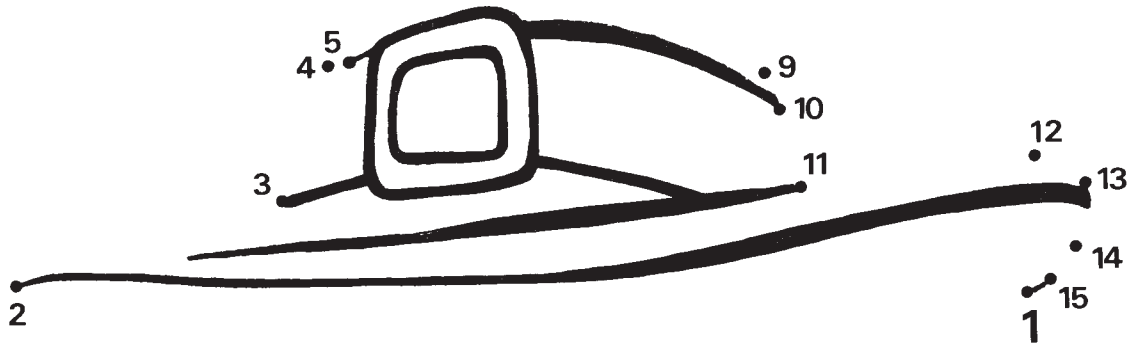





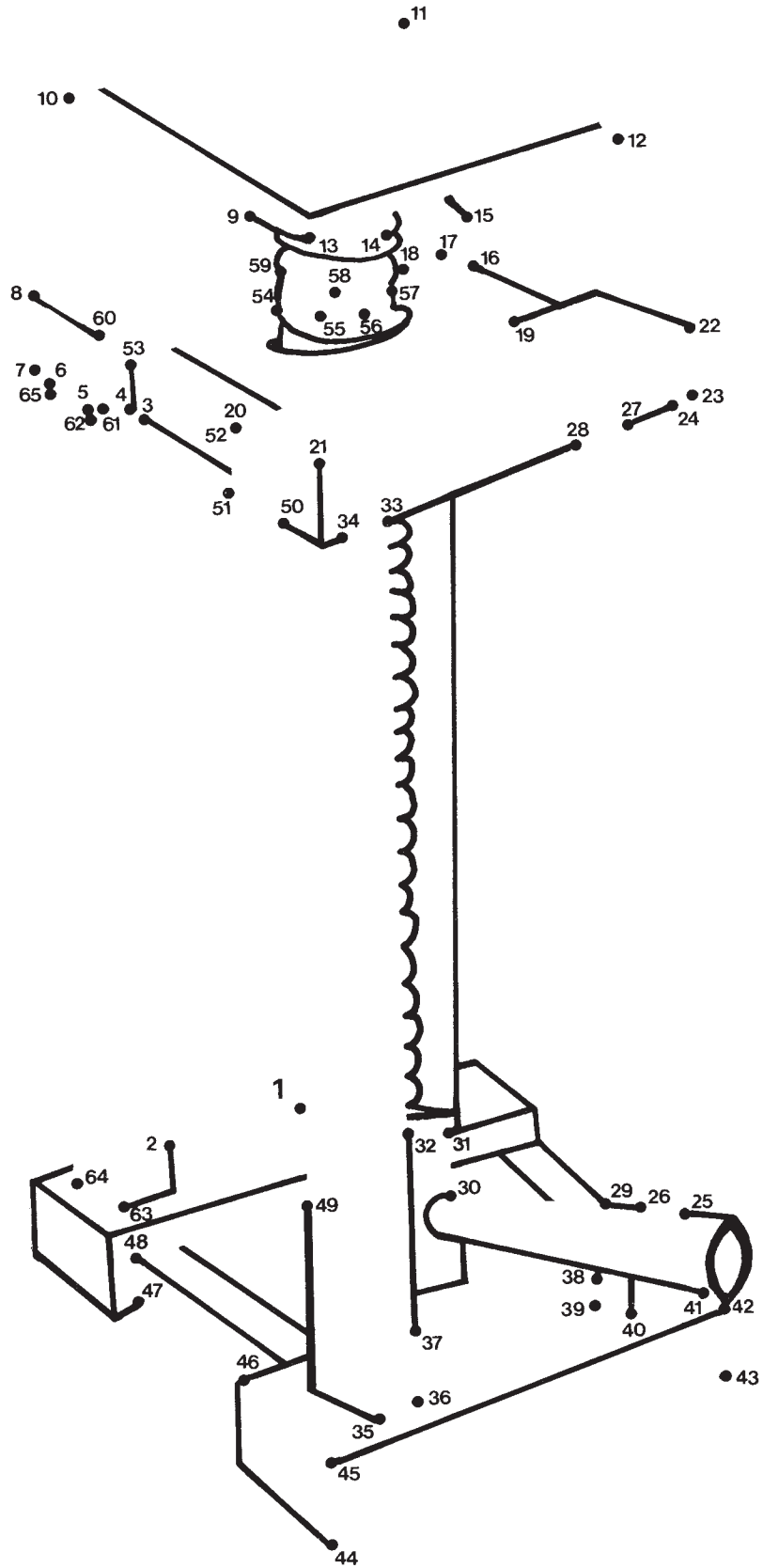

May be reproduced for non-commercial, personal or classroom use per Permission to Reproduce guidelines.  
 All other rights reserved. ©2008 NEST Family Learning

# WHICH PICTURES DO NOT BELONG?

Look closely at each line below and circle the picture that doesn't fit in with the rest.

1.

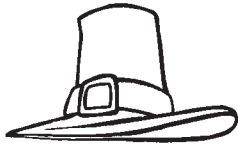

2.

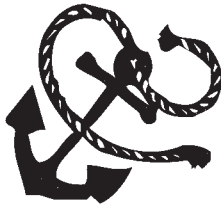
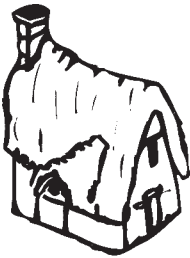

3.

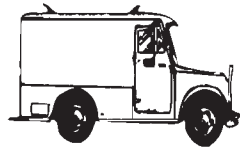
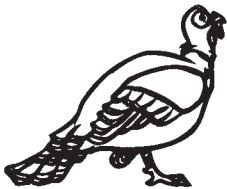

4.

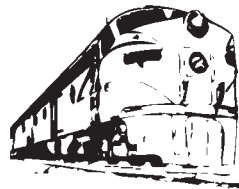
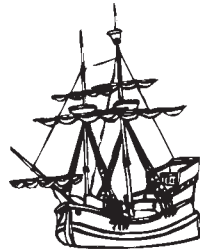

5.



# WHAT'S WRONG WITH THIS PICTURE?

Circle the 22 things that are wrong with the picture below.



# WORD SEARCH

Look in every direction to find the hidden words below:

A A E G N O P J A C K  
C M Q I H I L T X P S  
F E A U B N N Z V I X  
L R H T E D C F W L Z  
F I T U S I J G A G Q  
E C O R N A D M F R W  
A A F K H N Q K U I V  
S B O E R S H I P M P  
T J D Y E P B F I S H  
K S Q U A N T O A R G

AMERICA  
CORN  
FEAST  
FISH  
INDIANS  
JACK  
PILGRIM  
SHIP  
SQUANTO  
TURKEY

## WHICH WORD DOES NOT BELONG?

Circle the one word in each row that does not belong with the others.

- |              |                  |             |                |
|--------------|------------------|-------------|----------------|
| 1. Squanto   | Sitting Bull     | Samoset     | Massasoit      |
| 2. Pizza     | Turkey           | Fish        | Corn           |
| 3. Governor  | William Bradford | John Carver | Miles Standish |
| 4. Pilgrims  | Thanksgiving     | Mayflower   | Nina           |
| 5. Red Coats | Separatists      | Pilgrims    | Colonists      |

# WHICH HAPPENED FIRST?

Number each picture below in the order that they happened in the video.  
(For smaller children, xerox copy this page, and cut each picture apart.  
Then, have the child put them in the order that they happened in the video.)

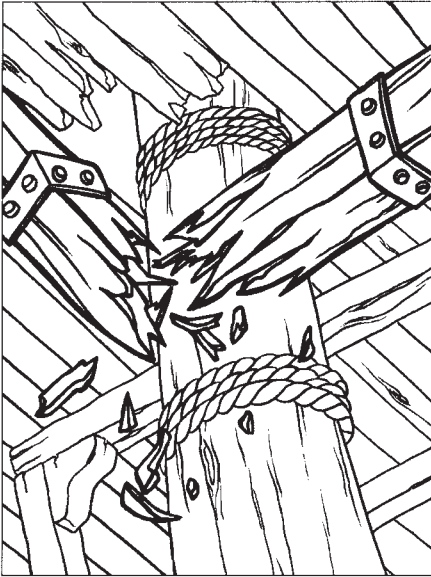



**Help the Mayflower bring  
the Pilgrims to America.**

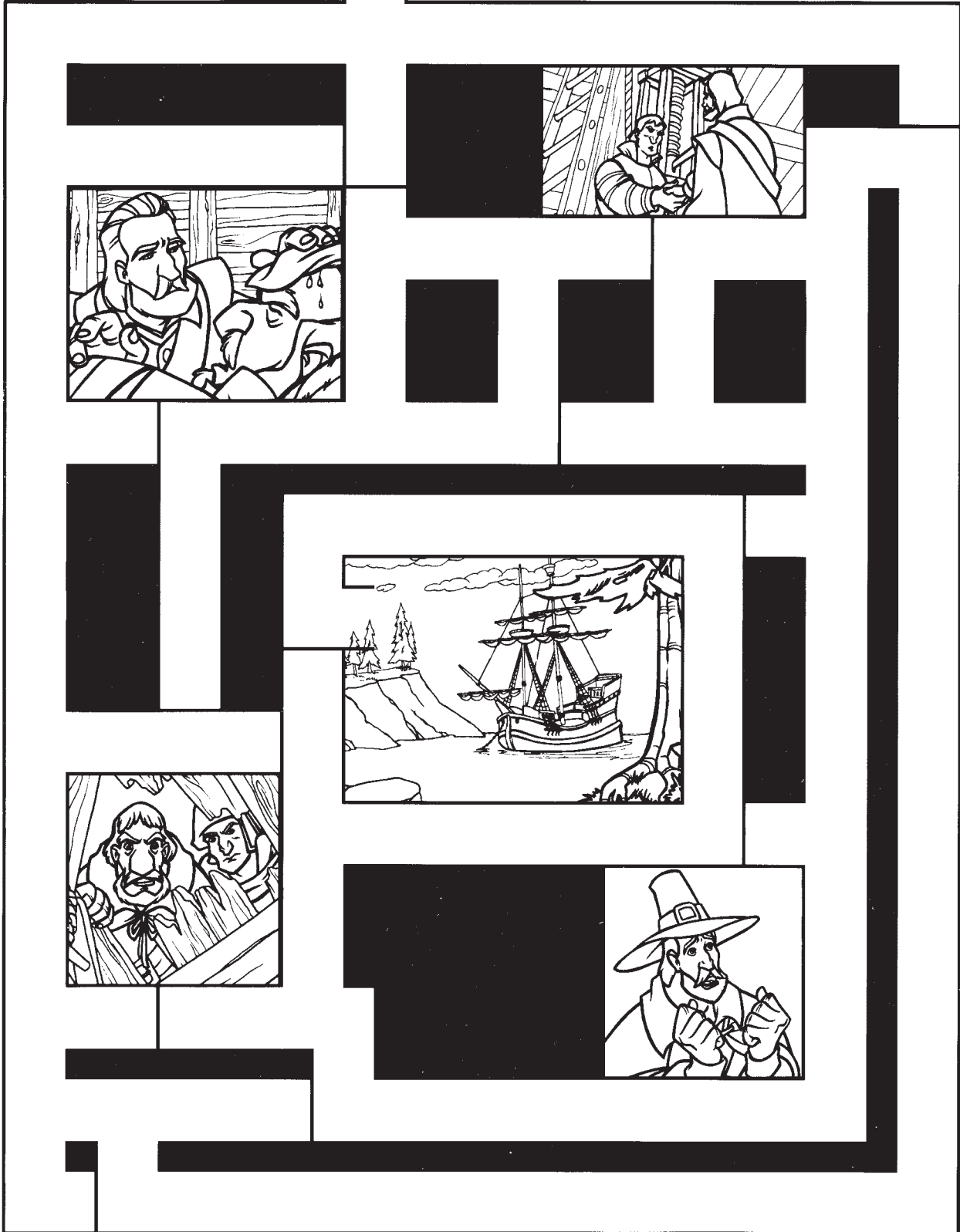

Help the Colonists make it through their first year in America.

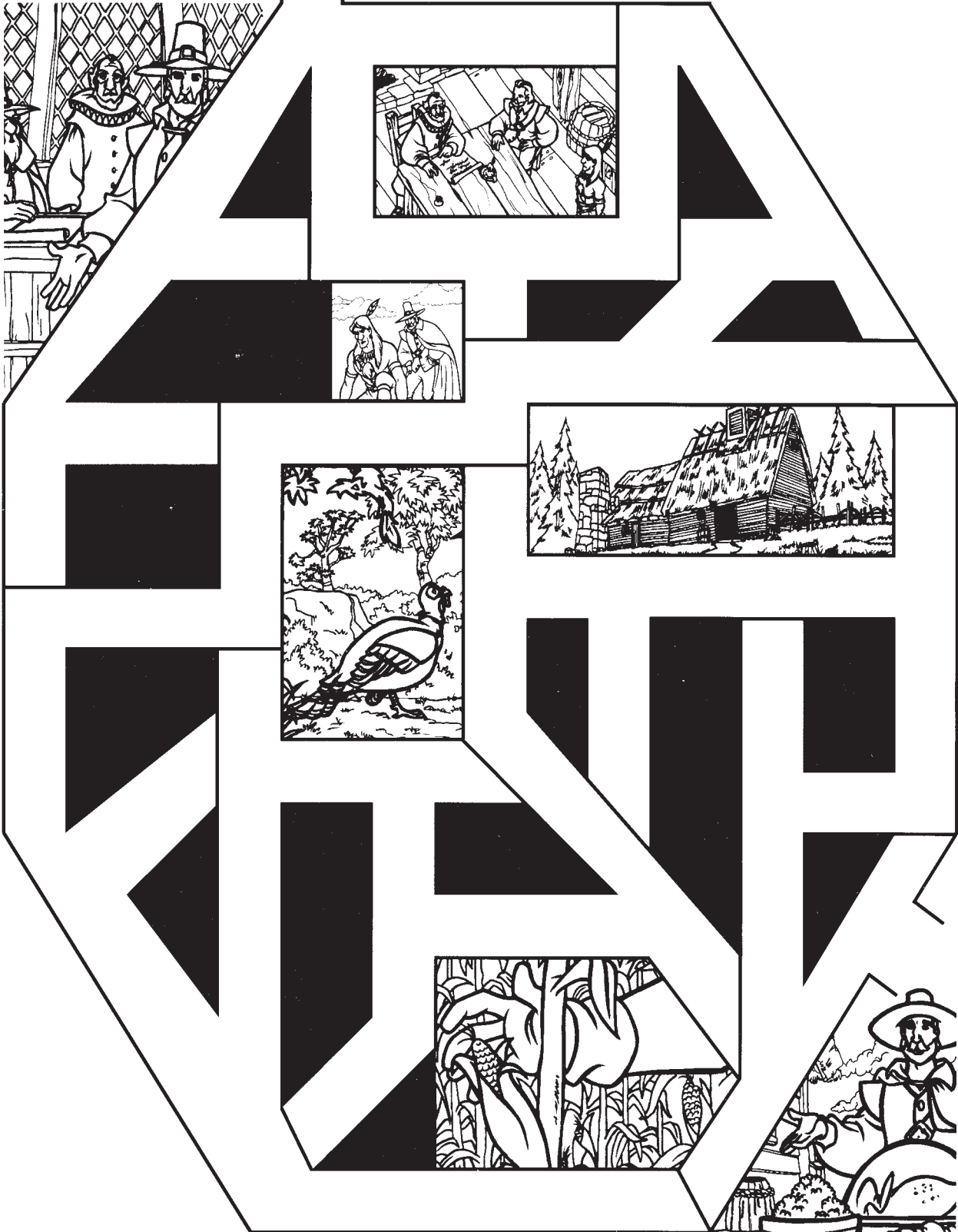



May be reproduced for non-commercial, personal or classroom use per Permission to Reproduce guidelines.  
All other rights reserved. ©2008 NEST Family Learning

# WHICH PICTURE IS NOT LIKE THE OTHERS?

Look closely at each picture and circle the one that is not alike in each row.

1. 

2. 

3. 

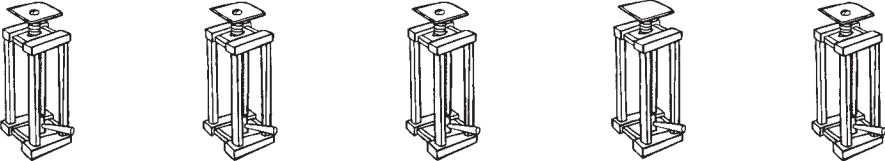
4. 

5. 

6. 

7. 

8. 

9. 

10. 



# COUNT THE DIAMONDS

There are 75 diamonds in the picture below. How many can you find?  
(Be careful! The complete diamond must be showing and lines must be on all sides.)



# CROSSWORD PUZZLE

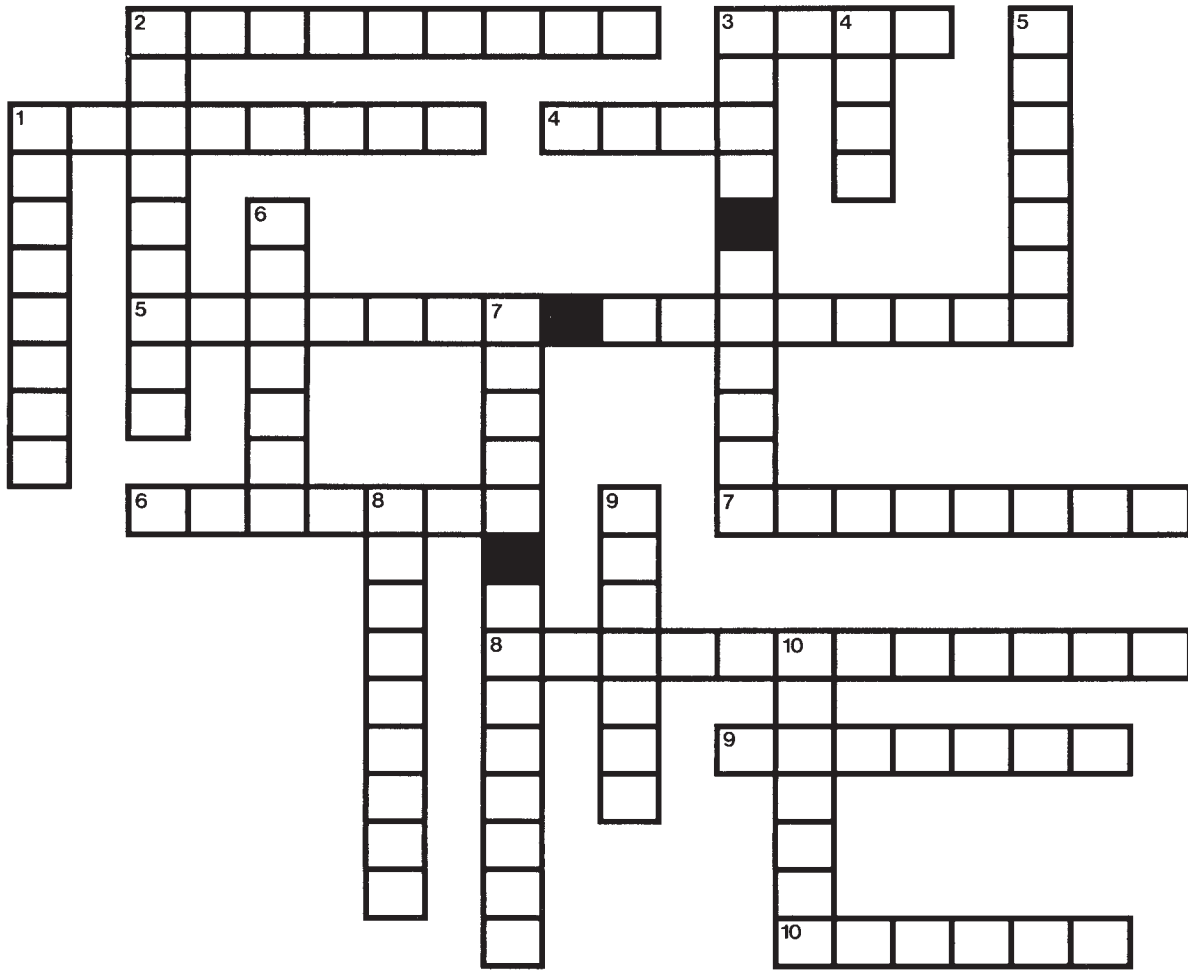

## DOWN:

1. Another name for the colonists who came to America.
2. Name of ship that colonists sailed to America in.
3. Was elected to be first Governor of colony. (2 words)
4. A crop the colonists planted that grows well in America.
5. Country where William Bradford and most of the Colonists originally came from.
6. Where colonists had hoped to sail to when they were captured by the English Magistrate.
7. Name of Captain who sailed to America with the colonists. (2 words)
8. What everyone signed before going ashore in America.
9. Indian that lived with the colonists.
10. First Indian to talk with the colonists.

## ACROSS:

1. What the colonists named their settlement.
2. Was the Chief of the Wampanoag Indians.
3. Was used to repair the mast on the ship.
4. What Squanto had colonists plant with their corn.
5. Was elected to be the second Governor of Plymouth. (2 words)
6. Who William Bradford wanted to be friendly towards.
7. The Pilgrims came to America so they could have freedom of \_\_\_\_\_.
8. Name of celebration that colonists had with the Indians.
9. Destination of the Mayflower.
10. A favorite Thanksgiving meat.

# WORD SEARCH

Look in every direction to find the hidden words below:

D S L C K Q N G U K M S R B U E B M F H D  
 B F G O O D M A N C O O K E H C V A L J A  
 S M O D E E R F S U O I G I L E R S K N O  
 E R V J X K L H P A M B M F G J U S Y E T  
 M W E Q A M M Z O Q G S K E V D D A O O R  
 A L R N S R D I Y F W R Y T R L P S U G W  
 J T N C Z N J G L X P J E O E Q C O R N I  
 G K O S A T G P E E P T F E Z K E I F I O  
 N J R L V D B I A T S D M A M H S T W V D  
 I G G I T O X C H A A S L K I E Z U E I J  
 K N T R A Q E Y N R I P T W G C N R M G P  
 E Y K D L W S X B T C O Z A Y F Z T I S R  
 I D H Z M S A M O S E T V Q N T E A W K C  
 H P Q T U Z A Y T I S W H E D D M B G N K  
 L O C N U I W R G G F O W N B N I E J A V  
 E U L Y L O I V H A T W T I W C V S R H N  
 H O X L U A M B L M O R P A K R P X H T S  
 F S I X A D T Y X R M A Y F L O W E R Z V  
 J W G M Q N E U L J S R E V R A C N H O J  
 A U P K M B D D N P V L Q O M H S K T F B

AGREEMENT  
 BAKER  
 ENGLAND  
 GOODMAN COOKE  
 GOVERNOR  
 HOLLAND  
 JOHN CARVER  
 KING JAMES  
 MAGISTRATE  
 MASSASOIT  
 MAYFLOWER  
 MILES STANDISH  
 MUSKET  
 NEW WORLD  
 PEACE  
 PLYMOUTH  
 RELIGIOUS FREEDOM  
 SAMOSET  
 THANKSGIVING  
 WILLIAM BRADFORD

## MATCHING GAME

Match each description on the left with the correct person or item on the right.

- |  |                     |
|--|---------------------|
| 1. ___ Captain who sailed to America with the colonists. | A. Samoset          |
| 2. ___ First Indian to talk to the Pilgrims.             | B. John Carver      |
| 3. ___ Where the Mayflower set sail from.                | C. William Bradford |
| 4. ___ Favorite Thanksgiving food.                       | D. Squanto          |
| 5. ___ Chief of Wamponoag Indian Tribe.                  | E. Miles Standish   |
| 6. ___ Was planted with corn.                            | F. Massasoit        |
| 7. ___ Second Governor of Plymouth                       | G. Fish             |
| 8. ___ Name of Pilgrim's Colony.                         | H. Turkey           |
| 9. ___ First Governor of Plymouth.                       | I. Plymouth         |
| 10. ___ Taught Pilgrims how to plant corn.               | J. England          |

# HIDDEN OBJECTS

Find the objects hidden in the picture below.



ant  
anchor  
arrow  
artists brush  
barber pole

bowl  
candle  
car  
flashlight  
heart

megaphone  
mushroom  
paper clip  
paw print  
pineapple

present  
pumpkin  
rosebud  
sailboat  
shamrock

snowman  
star  
tie  
whale  
wrench

# WHAT'S DIFFERENT?

There are 8 differences between these two pictures.  
See how many you can find by circling the picture on the right.



There are 6 differences between these two pictures.  
See how many you can find by circling the picture on the right.



May be reproduced for non-commercial, personal or classroom use per Permission to Reproduce guidelines.  
All other rights reserved. ©2008 NEST Family Learning

# WHAT'S DIFFERENT?

There are 16 differences between these two pictures.  
See how many you can find by circling the picture on the right.



There are 15 differences between these two pictures.  
See how many you can find by circling the picture on the right.

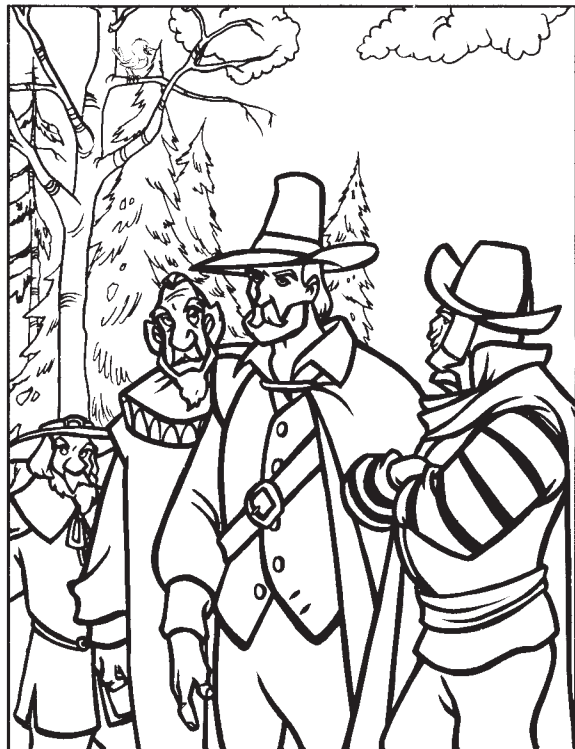

## THINGS FOR GROUPS TO DISCUSS AND DO

1. Give group copies of world map. Have them identify the continents, and then, trace the travels of the Pilgrims, first from England to Holland and back again, and then, from England to America.
2. Display samples of traps for class members to see. (Either real traps or pictures of traps.) Explain how traps are used to catch animals. (If you don't have access to larger traps, use a mouse trap to show group how a trap actually works. Be careful so that no one is hurt.) Discuss how the Pilgrims used traps to help provide the necessary food for their survival in America.
3. Have group find Thanksgiving Day on a calendar. (Fourth Thursday in November.) Discuss why we celebrate Thanksgiving Day. Allow group members to mention one thing that they are thankful for.
4. Discuss various foods that were eaten at the first Thanksgiving dinner. (i.e.: Turkey, venison or deer meat, fowls, fish, corn, etc.) Ask group which of these foods are still traditionally eaten today on Thanksgiving Day.
5. Help group have a mock first Thanksgiving Day. Have part of group dress as Indians with headbands and feathers and part dress as Pilgrims with Pilgrim hats and collars. Discuss what took place on the first Thanksgiving Day. (i.e.: Games, cooking, feasting, singing, praying, etc.) Games or food could even be prepared for group to sample.

## FACTS NOT FICTION

1. Did you know that there were 103 people on board the Mayflower?
2. Did you know that most of the people on board the Mayflower signed an agreement before going ashore in America which was called the Mayflower Compact?
3. Did you know that the first Thanksgiving celebration lasted for three days?
4. Did you know that the first Thanksgiving celebration was held in December and not November? It began on December 13, 1621, and lasted for three days.
5. Did you know that William Bradford was elected as Governor of Plymouth Colony 30 different times? He served from 1621 to 1656 with the exception of 1633, 1634, 1636, 1638 and 1644, when he was given a break. On the years that he was not the Governor, he was still elected as Assistant Governor.

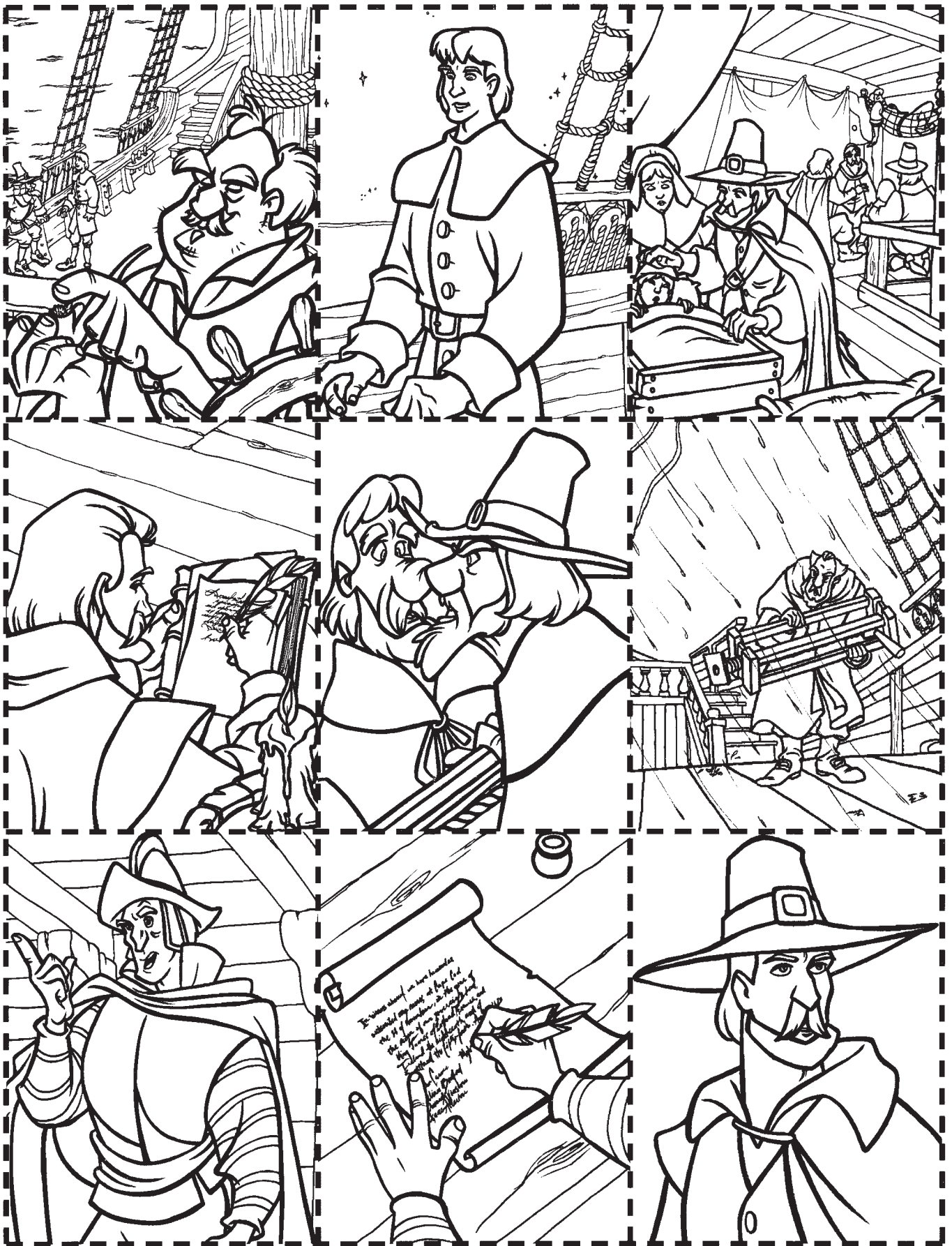

(See "Game Cards" on page 38)





# IDEAS FOR GROUP ACTIVITIES

**DRAWING GAME:** The group is divided into teams, and various scenes or people from the video are written on slips of paper. The teams then alternate taking the slips of paper out of a bowl and drawing the mentioned scene or person on a chalkboard or paper until team members guess what the scene or person is. A time limit should be given, and if the team is not able to guess the scene in the allotted amount of time, no point is earned. The other team is then given a chance to steal the point.

**CHARADES:** The group is divided into teams, and various scenes from the video are acted out.

**QUESTION AND ANSWER GAME:** The questions from each section are copied on a copy machine, cut apart, and placed in a bowl. The group is divided into teams, and each team takes turns drawing the question out of the bowl. Points are scored by correctly answering each question. If the team drawing the question cannot answer it correctly, the opposing team gets a chance to steal the point.

**MATCHING GAME:** The names from the matching game are put on an overhead or chalkboard, and the descriptions are copied on a copy machine, cut apart, and placed in a bowl. The group is divided into teams, and each team alternates taking a description out of the bowl and matching it with the correct name or item on the board. Points are scored by correctly matching the description with the name. If the team drawing the description cannot answer it correctly, the opposing team gets a chance to steal the point.

**WHO AM I?:** Qualities and descriptions of personalities in the video are read aloud one at a time. In this game, teams do not take turns, instead, a point is scored by the **first** team that is able to name the person being described. For example: William Bradford could be described as follows: Born in England; Second Governor of Plymouth, etc.

**THE DESCRIPTION GAME:** Names of various personalities in the video are written on slips of paper and placed in a bowl. The group is divided into teams, and each team takes turns drawing names out of the bowl and describing each personality to their team members. Once the team guesses correctly, the team member draws another name from the bowl. Each team is given 1 minute per turn to describe as many personalities as possible. Points are given for each correct answer. For example, if a team member drew “William Bradford” out of the bowl, the clues suggested in “Who Am I” could be given to help team members guess correctly. If the time allotment is not up by the time the team guesses correctly, the member draws another name from the bowl and continues until their time allotment is out.

**TWENTY QUESTIONS:** One member of the group is “it” and thinks of a person, place or thing from the video without telling anyone what the word is. The rest of the group asks him/her yes or no questions trying to figure out the word. If they fail to figure out the answer within 20 questions, the person who is “it” wins.

**HANG-MAN:** One member of the group is “it” and thinks of a word or phrase having to do with the video. He then puts a dash for every letter in the word or phrase on a paper or chalkboard. The rest of the group takes turns guessing letters. If a guessed letter is in the word or phrase, it is written into the corresponding blank on the board. If a guessed letter is not contained in the word or phrase, one part of the hang-man is drawn. If the hang-man is completed before the group finishes filling in the blanks, the person who is “it” wins.

**GAME CARDS:** Using the copy machine, make at least 2 copies of each page of “Game Cards” on card stock. Color them, if you wish, and then, laminated each page and cut apart. These games cards can be used for several different games such as “Concentration”, “Fish”, different versions of **Which Happened First** (page 25), etc.

# REFERENCES

# ANSWER KEY

for  
Questions,  
Games,  
and  
Activities





# ANSWER KEY

## Questions, Games & Activities

### Answers to Questions:

1. They were arrested by an English Magistrate because they didn't have a license to leave the country. All their belongings were taken from them and became the property of King James of England.
2. So they could have freedom of religion.
3. 1620.
4. The Mayflower.
5. Because the main mast broke and was unstable.
6. They needed it to build their new church in America.
7. It was used to stable the main mast so that they could continue on to America and not return to England.
8. John Carver.
9. Plymouth.
10. Samoset.
11. Squanto and Samoset.
12. Squanto.
13. Over half of the 103 people who had come to America died.
14. Because Plymouth Colony was where his tribe, the Patuxet Indians had lived. Even though his tribe was all dead, he felt like this land was still his home.
15. They all got sick and died.
16. White traders and fishermen that visited America had taught him English. He was also taken to England as a slave where he learned to speak English even better.
17. He taught them how to fish; how to plant crops; how to hunt; how to lay traps; how to tap trees for sap; etc.
18. William Bradford.
19. Thanksgiving.
20. They were giving thanks because they had survived their first year in America.

### Answers to Which Picture Does Not Belong:

1. 
2. 
3. 
4. 
5. 

### Answers to What Is Wrong With This Picture?



# ANSWER KEY

## Questions, Games & Activities

### Answers to Word Search:

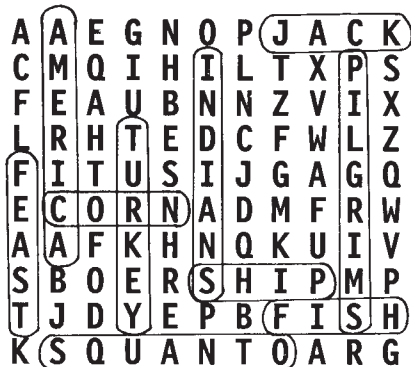

### Answers to Which Word Does Not Belong?

- Squanto (Sitting Bull) Samoset Massasoit
- (Pizza) Turkey Fish Corn
- Governor William Bradford John Carver (Miles Standish)
- Pilgrims Thanksgiving Mayflower (Nina)
- (Red Coats) Separatists Pilgrims Colonists

### Answers to Which Happened First?

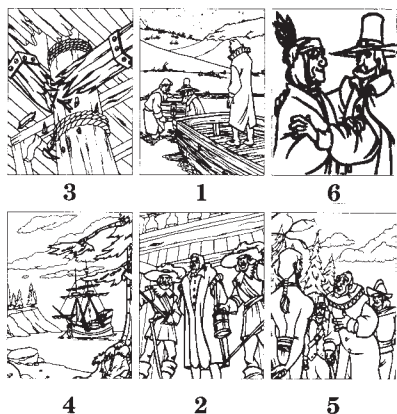

### Answer to Help Mayflower Maze:

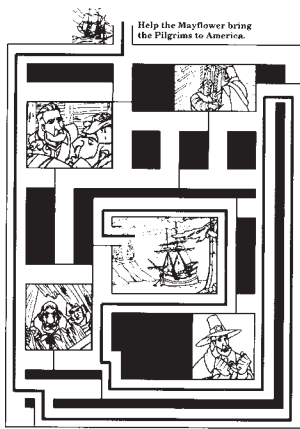

### Answer to Help Colonists Maze:



### Answers to Hidden Diamonds:



### Answers to Crossword Puzzle:

#### Across

- Plymouth
- Massasoit
- Jack
- Fish
- William Bradford
- Indians
- Religion
- Thanksgiving
- America
- Turkey

#### Down

- Pilgrims
- Mayflower
- John Carver
- Corn
- England
- Holland
- Miles Standish
- Agreement
- Squanto
- Samoset

### Answers to Which Picture Is Not Like the Others?

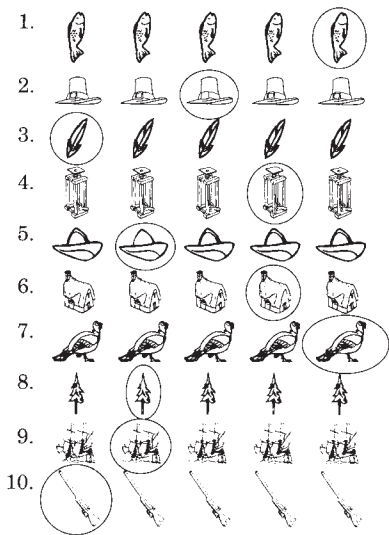



# Certificate of Achievement

This certifies that

\_\_\_\_\_ has mastered the

# William Bradford

**RESOURCE & ACTIVITY**

**from NEST Family Entertainment™**

by successfully completing all of the puzzles, games, and activities found herein.

\_\_\_\_\_ As of this date



*NEST Family Entertainment*

# Enjoy the Lessons of History...



William Bradford fled with the Pilgrims to the new world, where he discovered that the price for religious freedom was hunger, sickness and death. As a peacemaker, he befriended the Native Americans who taught the struggling Pilgrims how to survive. By the end of the first year, William Bradford became Governor of the new land. After their first critical harvest, he set aside time for the Pilgrims and their new Native American friends to feast together and express their thanks to God. Thus, William Bradford became the Father of Thanksgiving Day.

NEST Family Entertainment Products are Recognized for Excellence in Family and Children's Entertainment.



Watch as children are drawn into The Animated Hero Classics® series! Then, the fun and learning continue as they build on their biographical and historical knowledge by exploring the lessons further with this series of Resource & Activity Books full of curriculum related activities, problem solving, learning assessment tools as well as word games, puzzles and coloring pages. Each book in the Animated Hero Classics® series is an adventure for children of all ages and the perfect way to encourage continued learning discovery!



Collect the other titles in NEST's animated Hero Classics collection:

- |                      |                       |
|----------------------|-----------------------|
| Thomas Edison        | Alexander Graham Bell |
| George Washington    | The Wright Brothers   |
| Harriet Tubman       | Maccabees             |
| Christopher Columbus | Helen Keller          |
| Benjamin Franklin    | Leonardo da Vinci     |
| Florence Nightingale | Joan of Arc           |
| William Bradford     | Marco Polo            |
| Pocahontas           | Galileo               |
| Abraham Lincoln      | Marie Curie           |
| Louis Pasteur        | Beethoven             |

 **NEST Family Entertainment**™

1461 S. Beltline Rd., Ste 500, Coppell, TX 75019

TM, ® & © 2005 NEST. All rights reserved. r 2.0  
Printed in the USA



ISBN 1-56489-929-2